

**120 min**

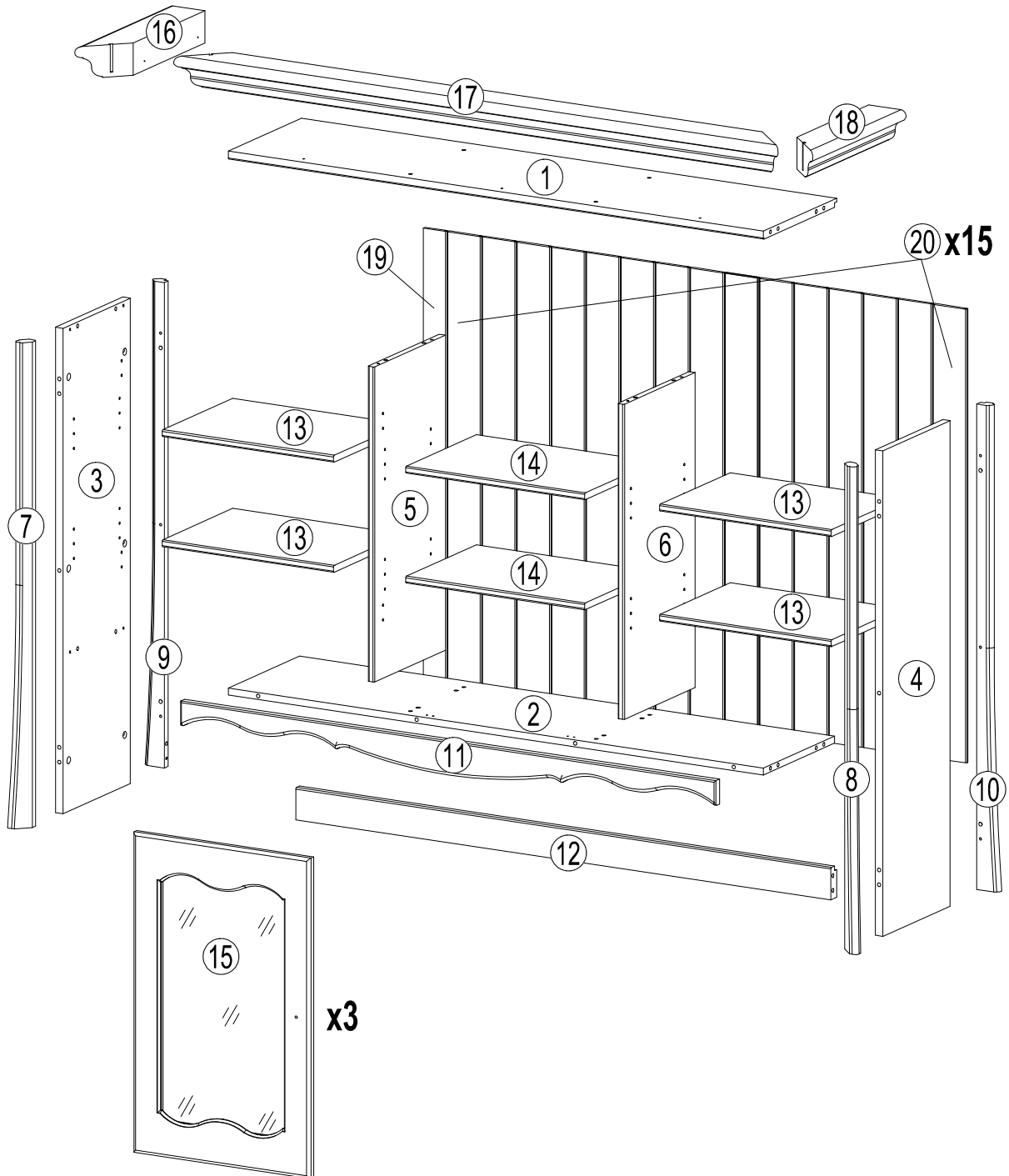
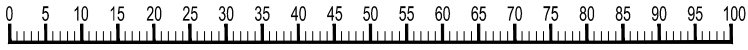
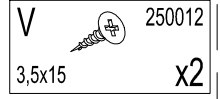
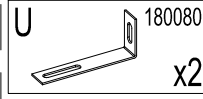
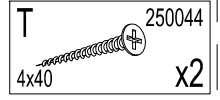
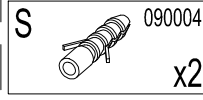
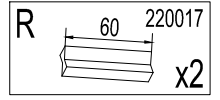
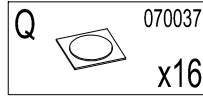
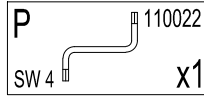
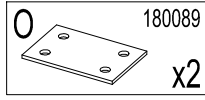
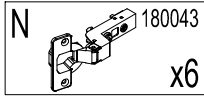
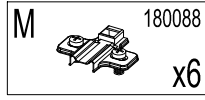
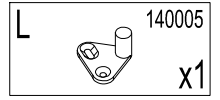
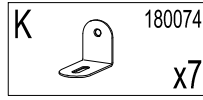
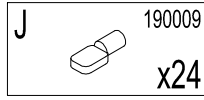
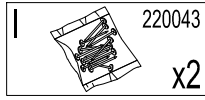
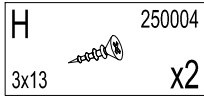
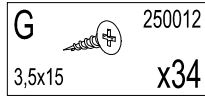
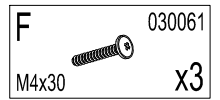
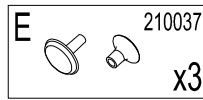
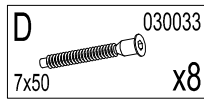
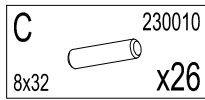
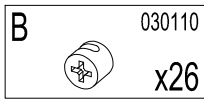
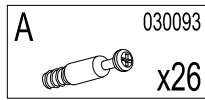

1

A 030093 x26

C 230010 8x32 x26

G 250012 3,5x15 x7

H 250004 3x13 x2

K 180074 x7

L 140005 x1

M 180088 x6

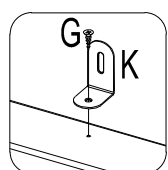
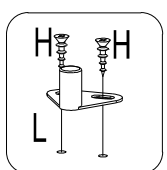
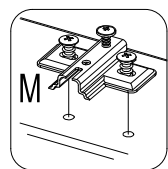
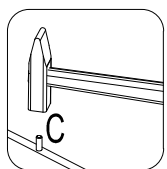
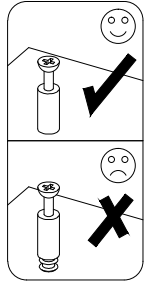
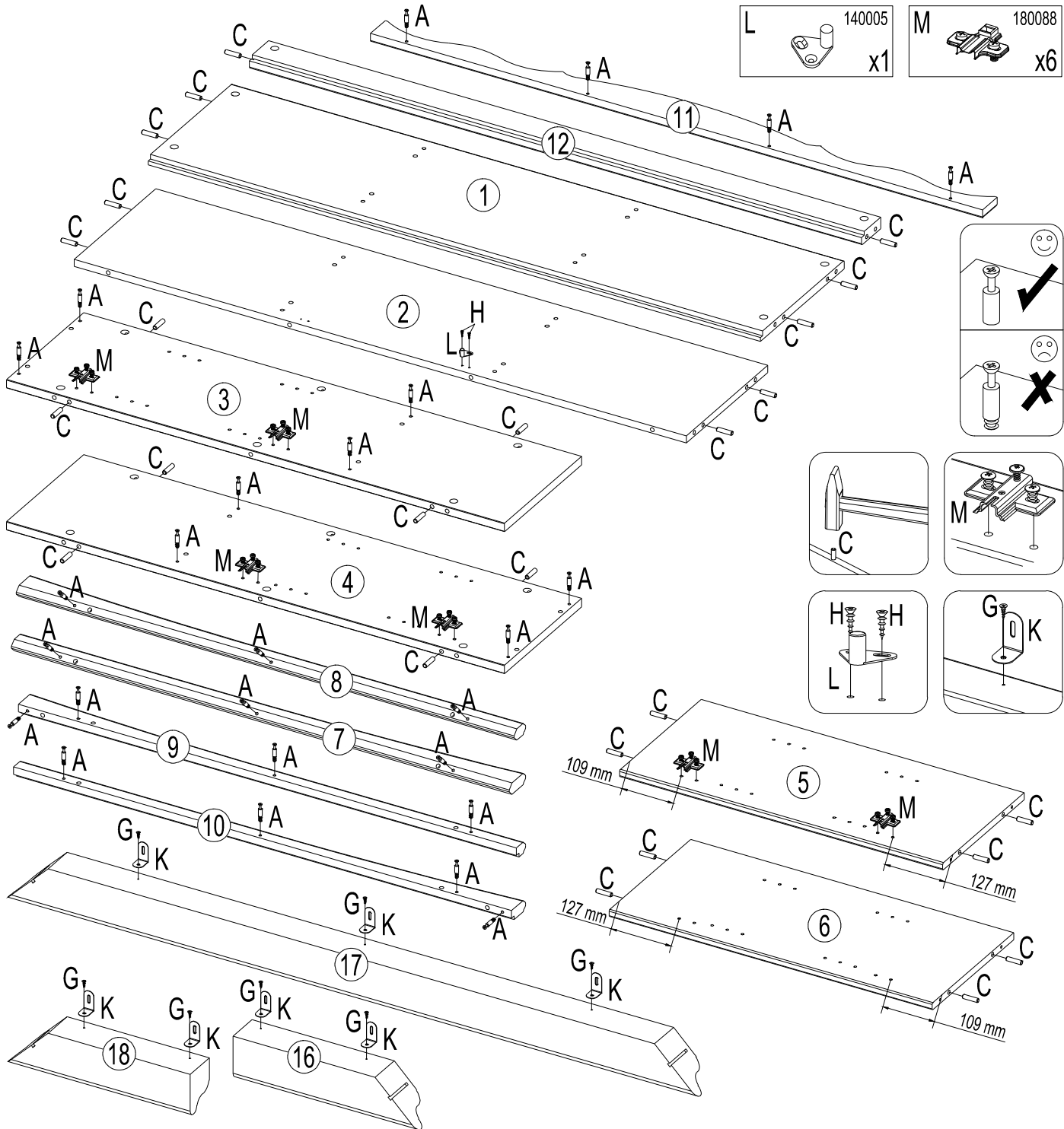

2

E 210037 x3

F 030061 M4x30 x3

G 250012 3,5x15 x12

N 180043 x6

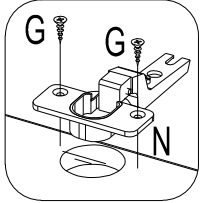
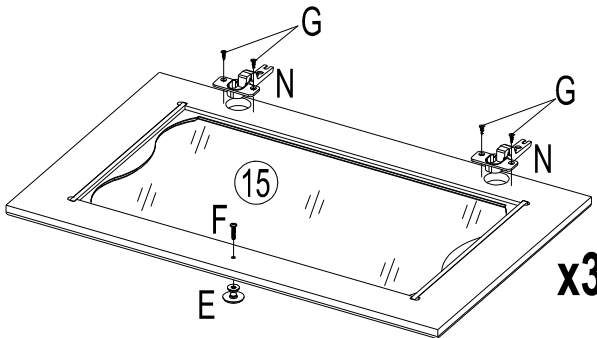

3-6

3

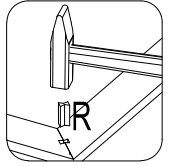
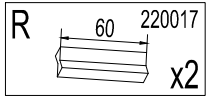
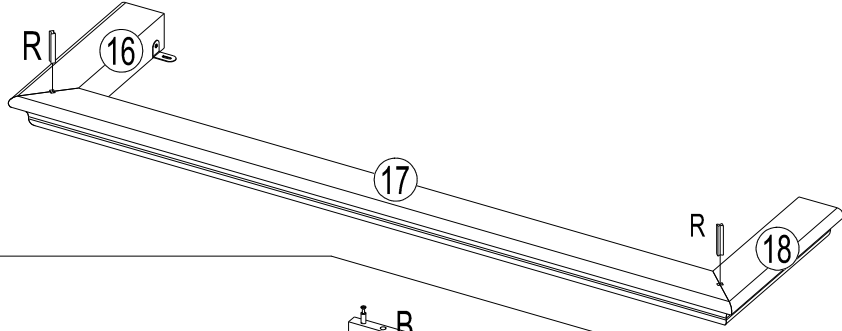

4

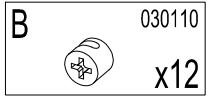
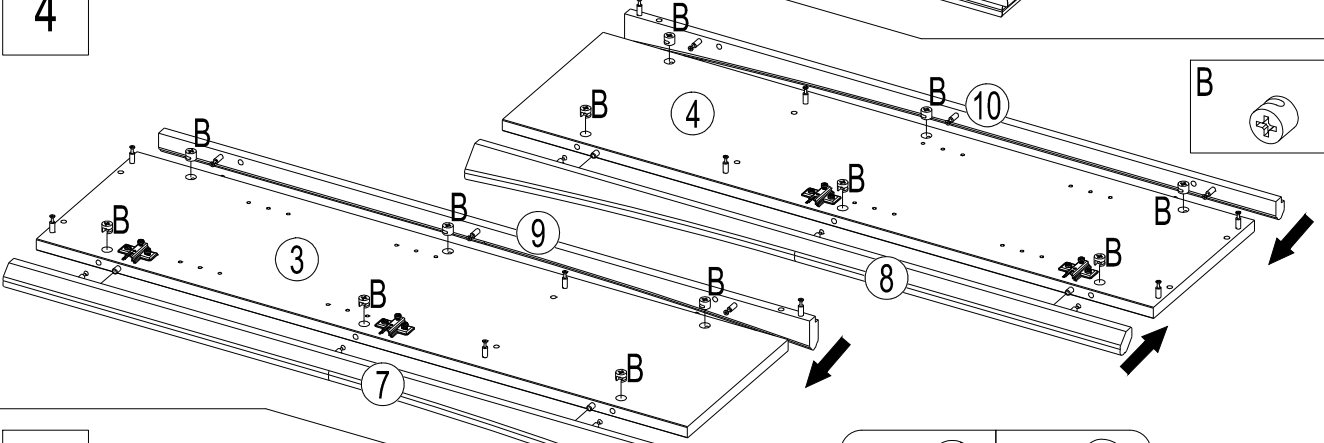

5

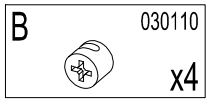
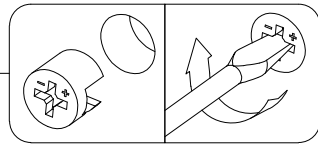
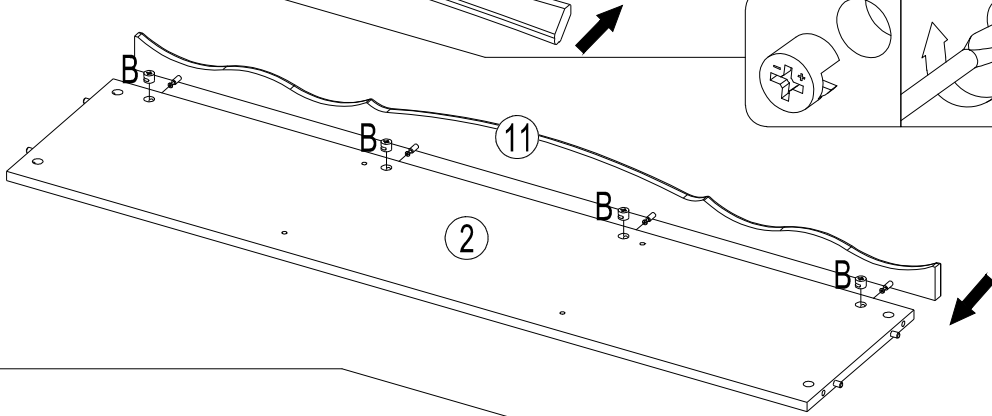

6

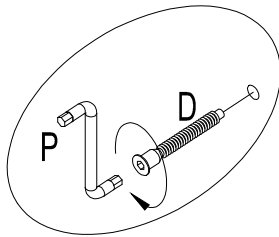
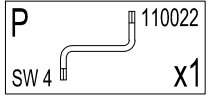
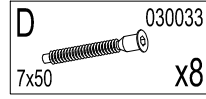
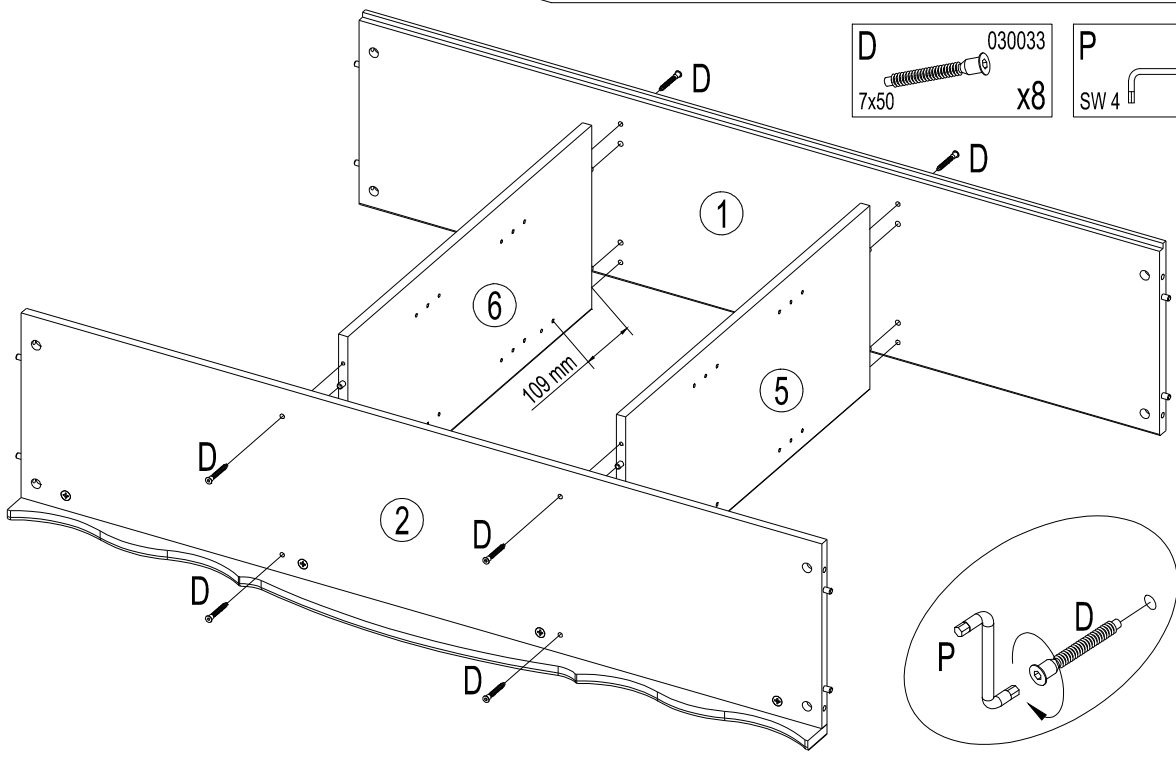

4-6

7

B 030110  
x10

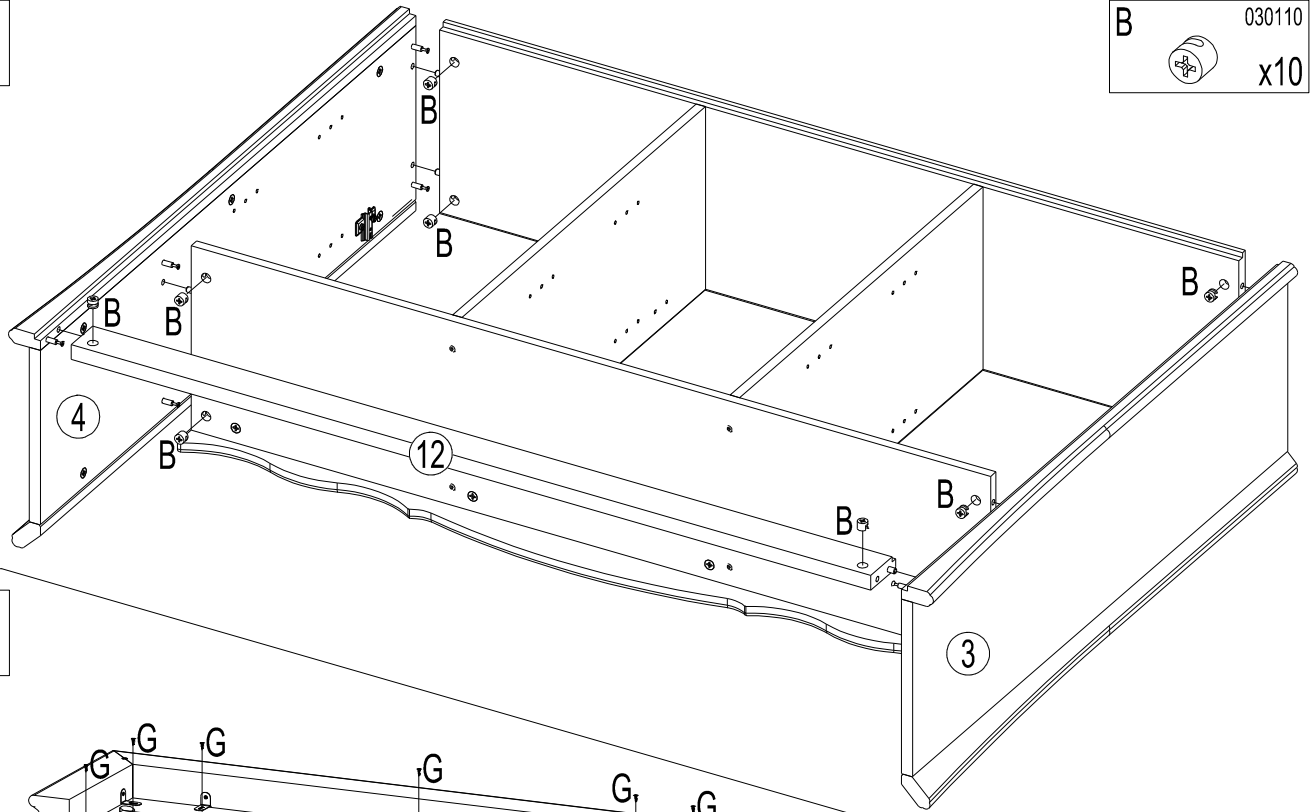

8

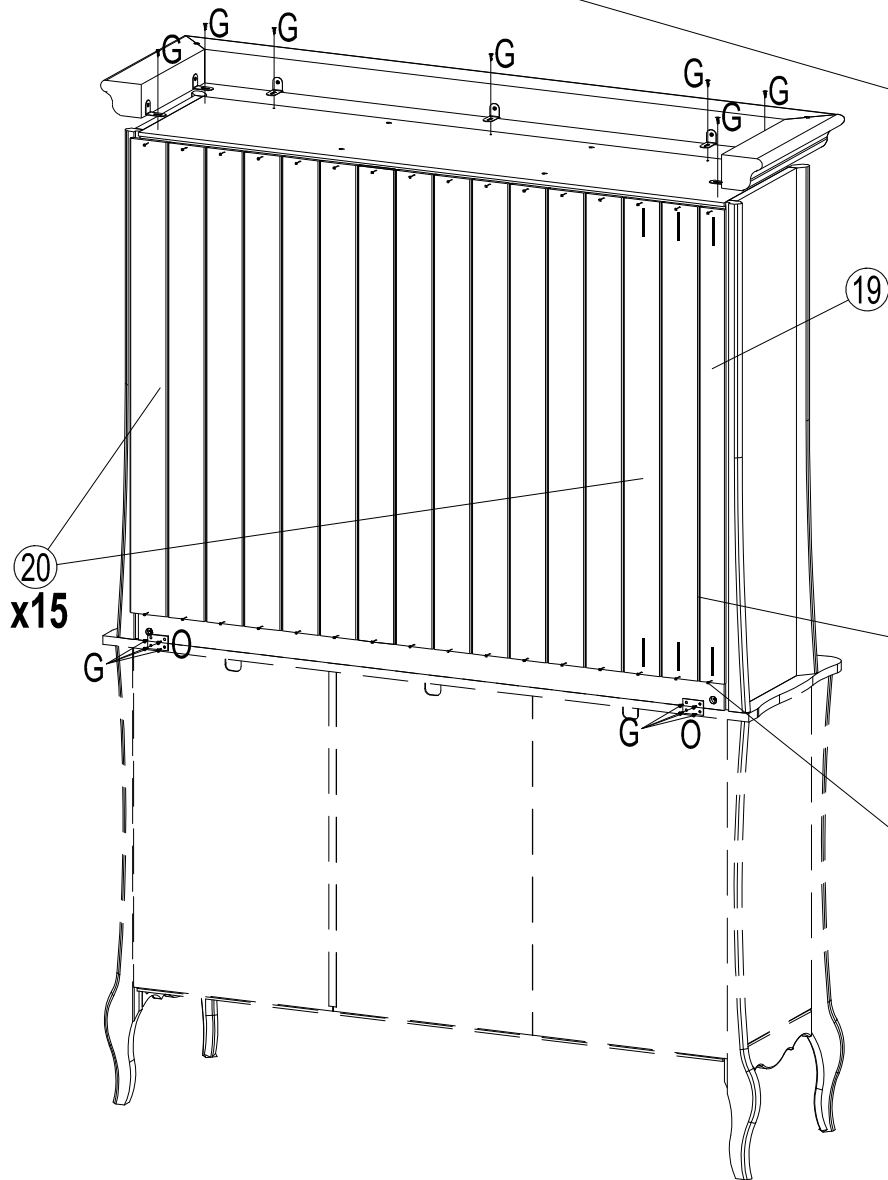

G 250012  
3,5x15 x15

I 220043  
x2

O 180089  
x2

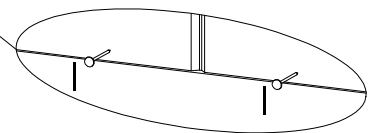
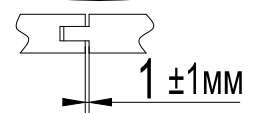
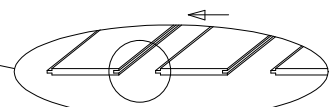
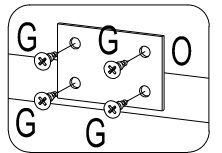

5-6

9

J 190009  
x24

Q 070037  
x16

S 090004  
x2

T 250044  
4x40 x2

U 180080  
x2

V 250012  
3,5x15 x2

