

45 min

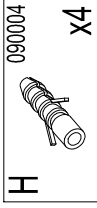

Nº	Size/MaB (mm)	Qty	✓	Nº	Size/MaB (mm)	Qty	✓
1V	986x300x24	1		3V	901x25x25	1	
2V	1086x240x30	1					

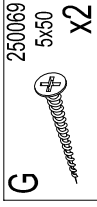
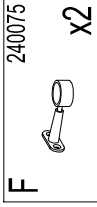
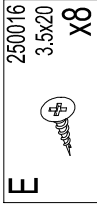
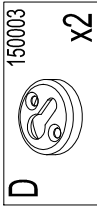
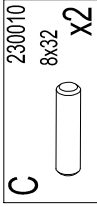
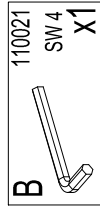
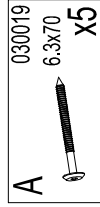
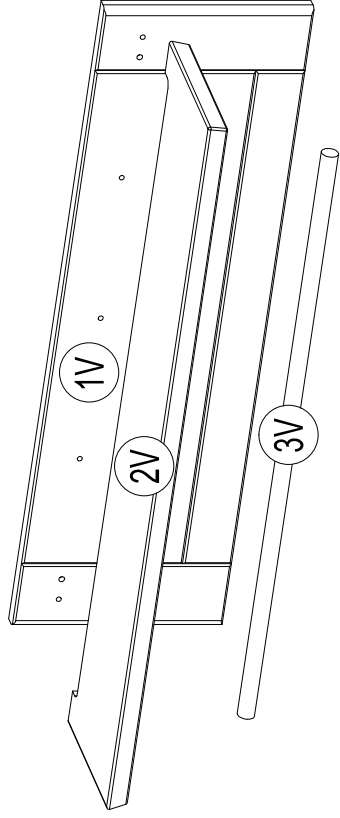