

Бетти

Антресоль-купе 4-ств

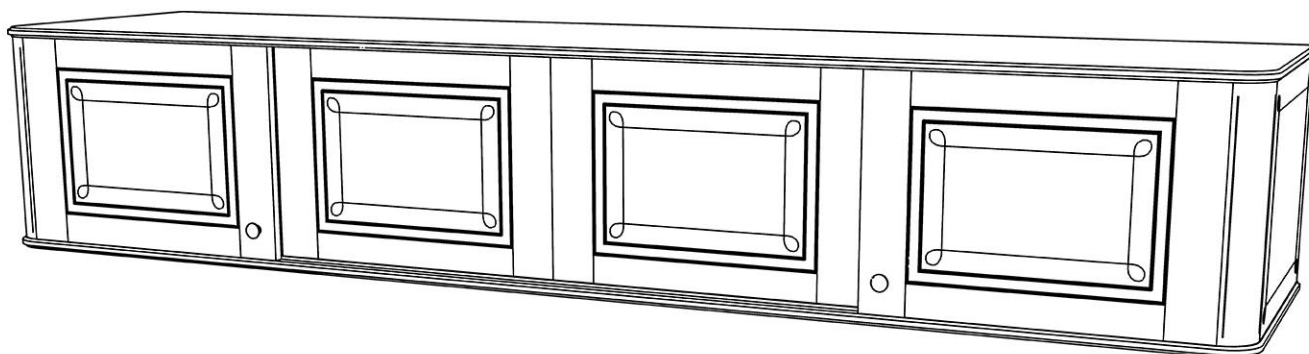

1038
52



1096
30



1097
30



1004
20



1



1007
4



2002
2

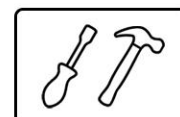

 **TIMBERICA**

RU Инструкция по сборке
EN Assembly instruction
FI Koontaohje



1

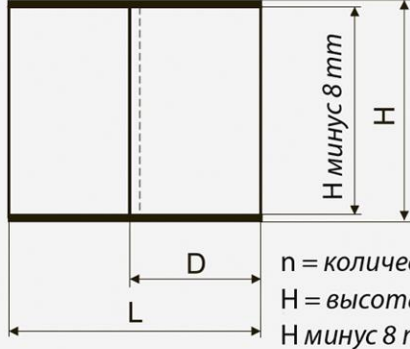

$$D = \frac{L + (n-1) \cdot z}{n}$$

$n = 2, 3, 4, \dots$

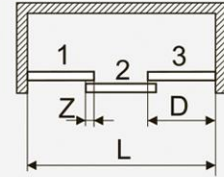

n = количество дверных створок

H = высота дверного проема

H минус 8 мм = высота двери

z - 40 мм
рекомендовано

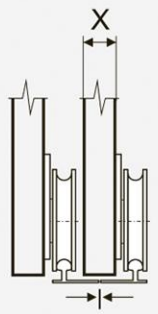

2 A

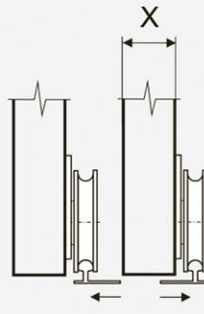

2 B

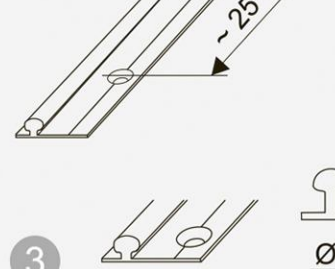

3



$\varnothing 3,5 \times 16$

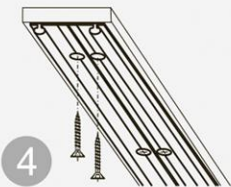

4



$\varnothing 4 \times 16$

5

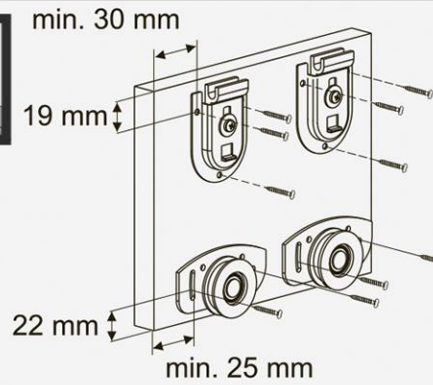

6

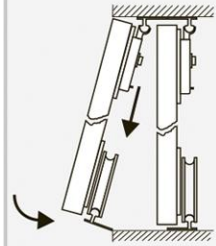

7

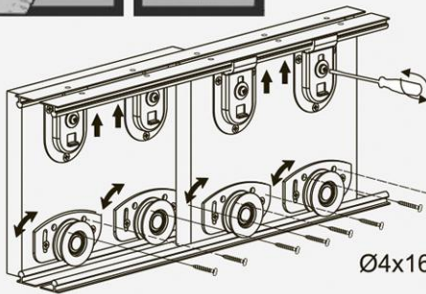

8

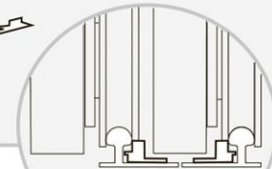
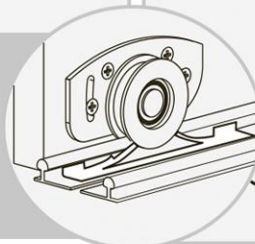
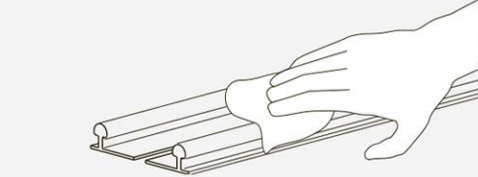

VALCOMP
WWW.VALCOMP.PL

