

# Грета

Шкаф книжный №8, №9, №10

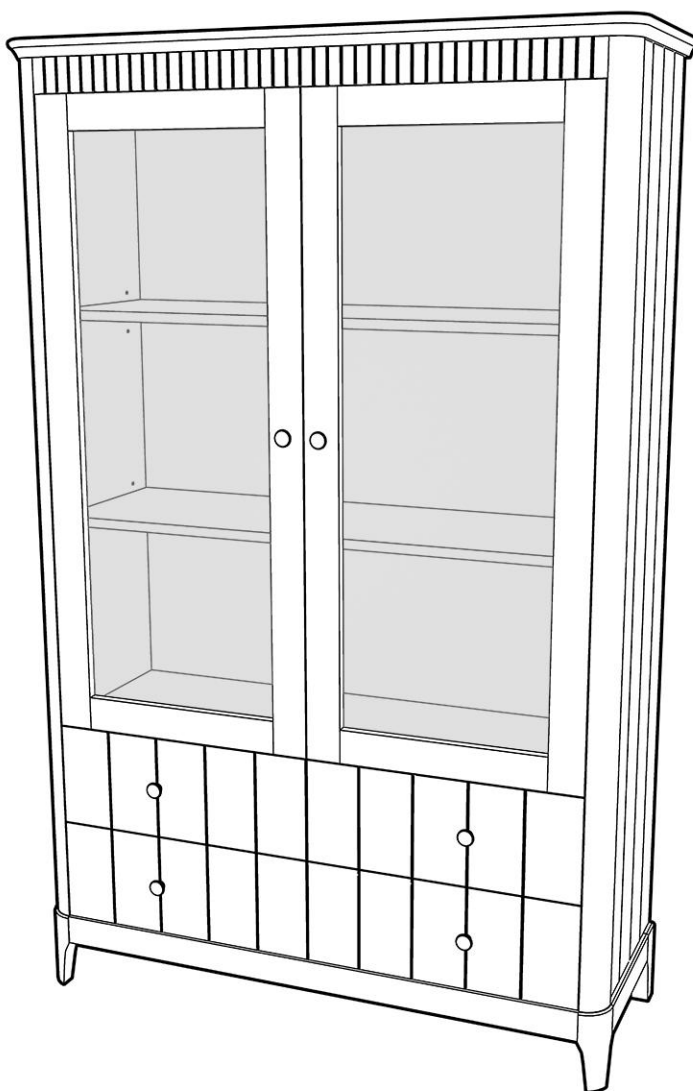

 **TIMBERICA**

- RU** Инструкция по сборке
- EN** Assembly instruction
- FI** Koontaohje

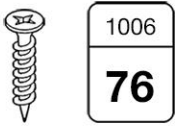

1006  
**76**



2002  
**6**



1038  
**52**



1097  
**36**



1096  
**36**

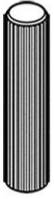

1004  
**10**



1013  
**4**

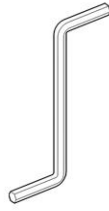

1034  
**1**

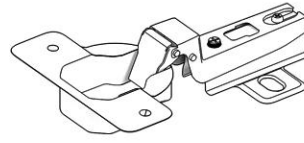

1024  
**4**



1040  
**8**



1039  
**20**



1008  
**8**

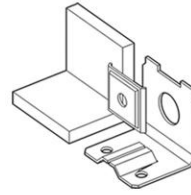

1099  
**2**

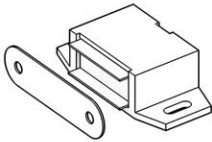

1042  
**2**

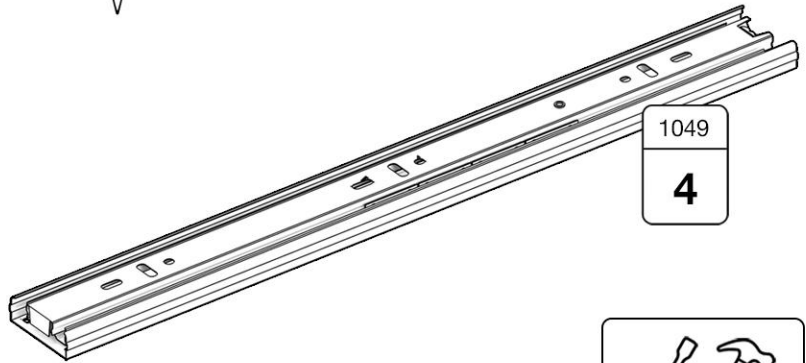

1049  
**4**

