

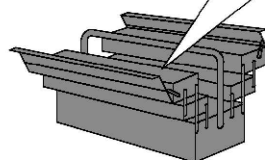

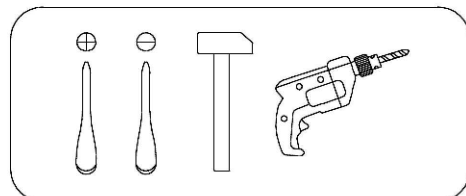

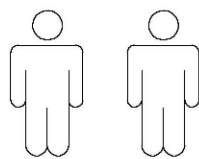



- |           |                                    |           |                                |
|-----------|------------------------------------|-----------|--------------------------------|
| <b>D</b>  | <b>Montageanleitung</b>            | <b>GB</b> | <b>Assembly instructions</b>   |
| <b>FR</b> | <b>Notice de montage</b>           | <b>IT</b> | <b>Istruzioni di montaggio</b> |
| <b>NL</b> | <b>Handleiding voor de montage</b> | <b>PL</b> | <b>Instrukcja montażu</b>      |
| <b>CZ</b> | <b>Montážní návod</b>              | <b>SK</b> | <b>Návod na montáž</b>         |
| <b>HU</b> | <b>Szerelési útmutató</b>          | <b>RO</b> | <b>Instrukțiuni de montaj</b>  |
| <b>TR</b> | <b>Montaj talimatı</b>             | <b>RU</b> | <b>Инструкция по монтажу</b>   |



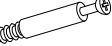



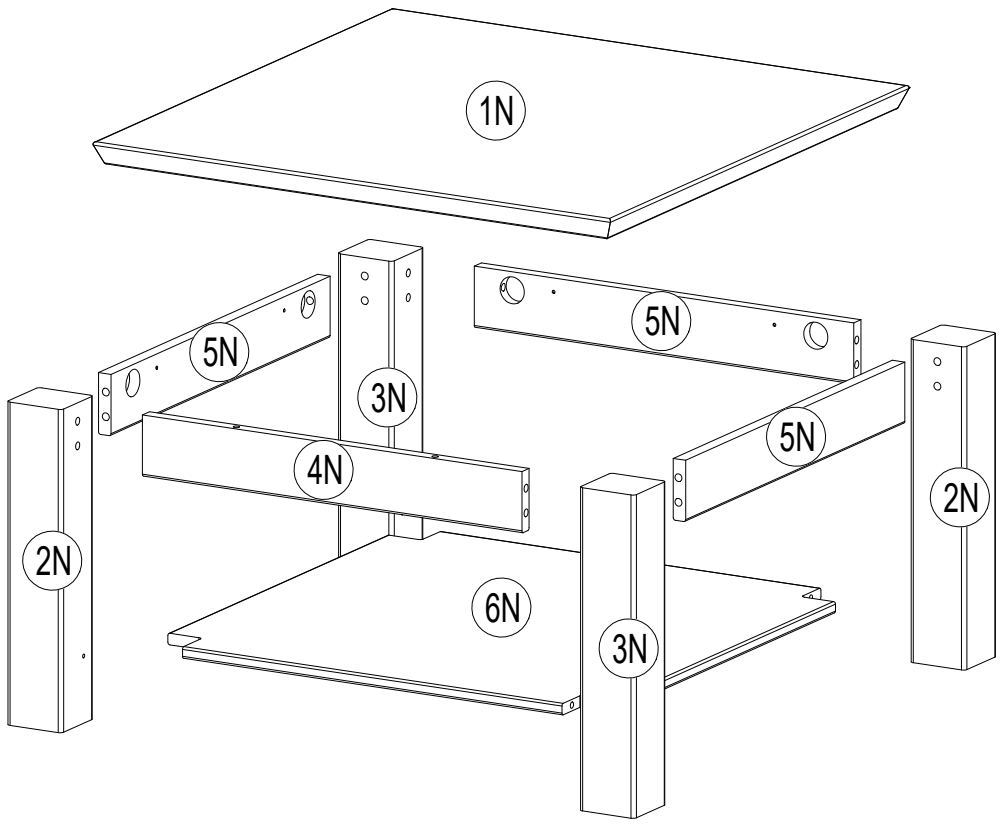

1-3

**EAC**

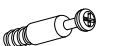

- |  |   |  |  |  |
|--|---|--|--|--|
| <b>A</b><br> x4 | <b>B</b><br> x4            | <b>C</b><br> x8         | <b>D</b><br> x8 | <b>E</b><br> 8x32<br>x2 |
| <b>F</b><br> x8 | <b>G</b><br> 3.5x15<br>x16 | <b>H</b><br> SW 6<br>x1 | <b>I</b><br> x8 |  |



- |          |  |  |  |  |  |  |
|----------|--|--|--|--|--|--|
| <b>1</b> | <b>A</b><br> x4 | <b>C</b><br> x8 | <b>D</b><br> x8 | <b>E</b><br> 8x32<br>x2 | <b>F</b><br> x8 | <b>G</b><br> 3.5x15<br>x8 |
|----------|--|--|--|--|--|--|

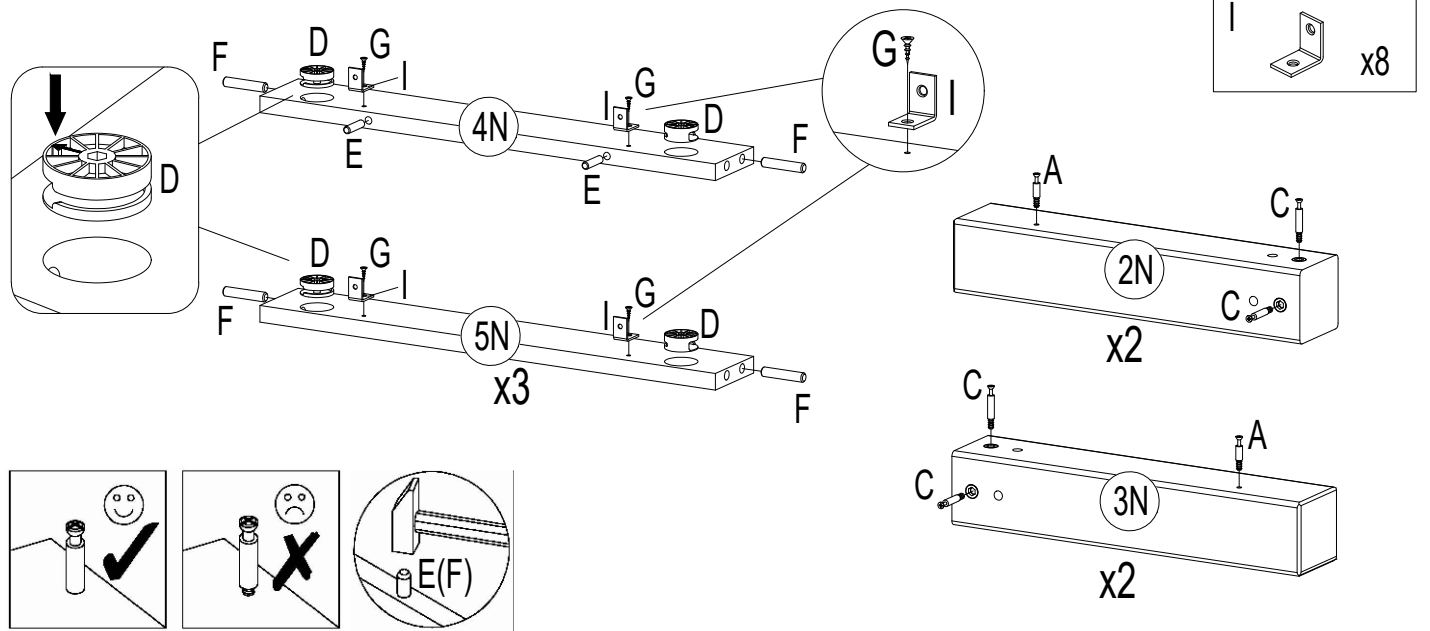

2

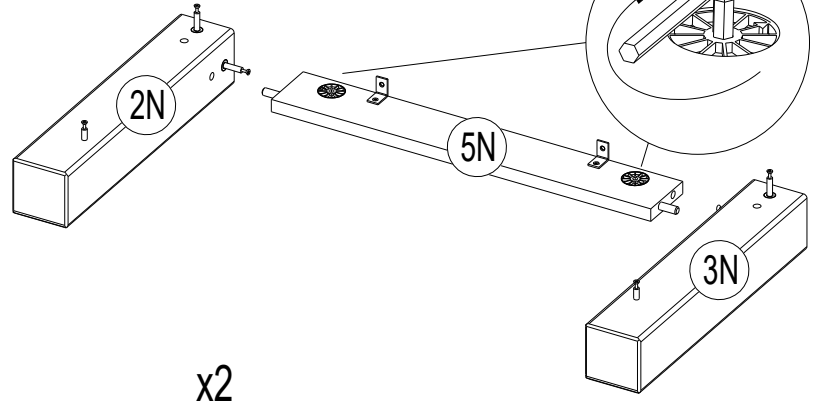
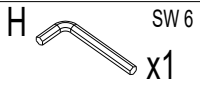

x2

3

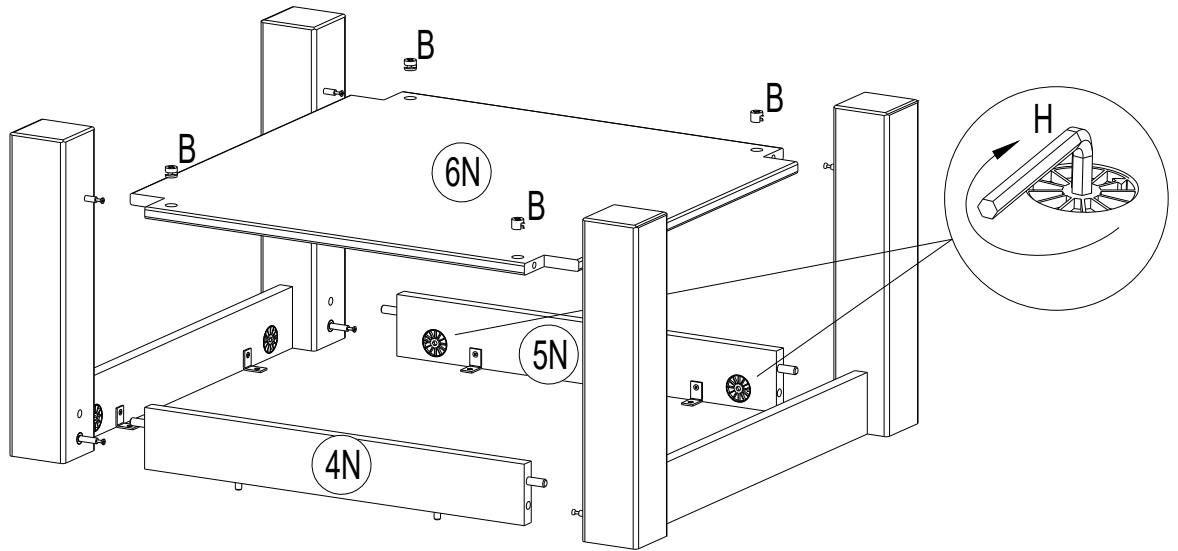
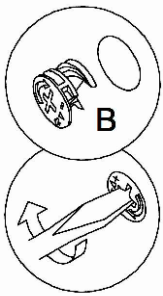
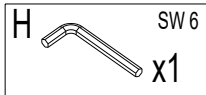
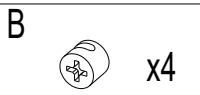

4

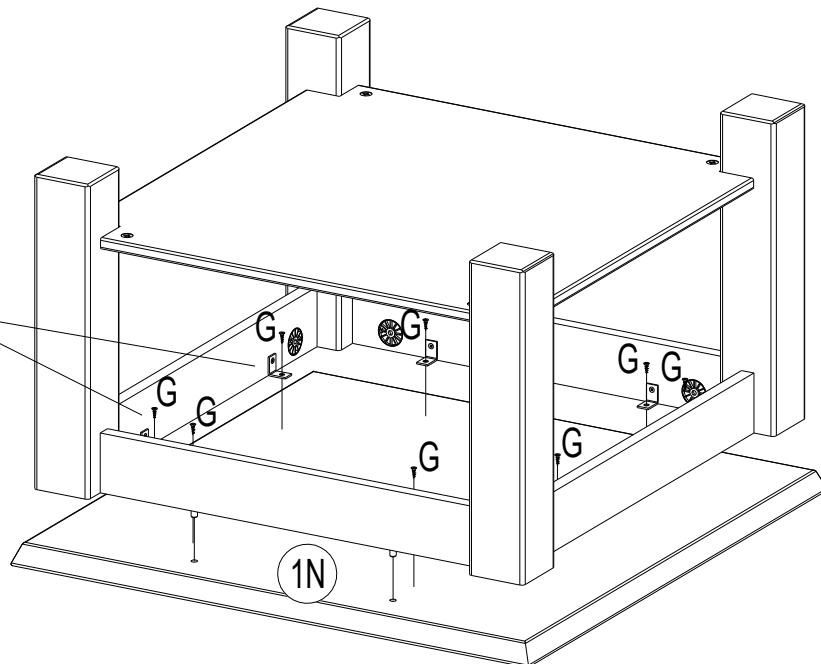
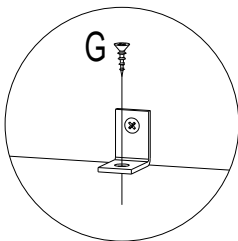
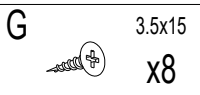

3-3