

# Ари-Прованс

Буфет 3-створчатый №2



 **TIMBERICA**

**RU** Инструкция по сборке

**EN** Assembly instruction

**FI** Koontaohje



1006  
**108**



1020  
**6**



1004  
**22**



1096  
**58**



1097  
**58**



1038  
**56**



1039  
**30**



1040  
**24**

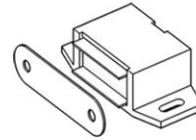

1042  
**3**

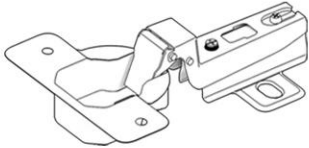

1024  
**8**

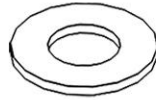

1024  
**32**



1008  
**16**

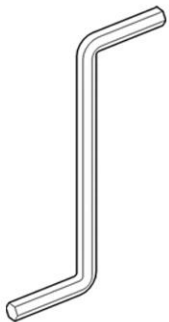

1024  
**1**

1075  
**8**



1013  
**2**

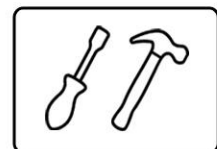
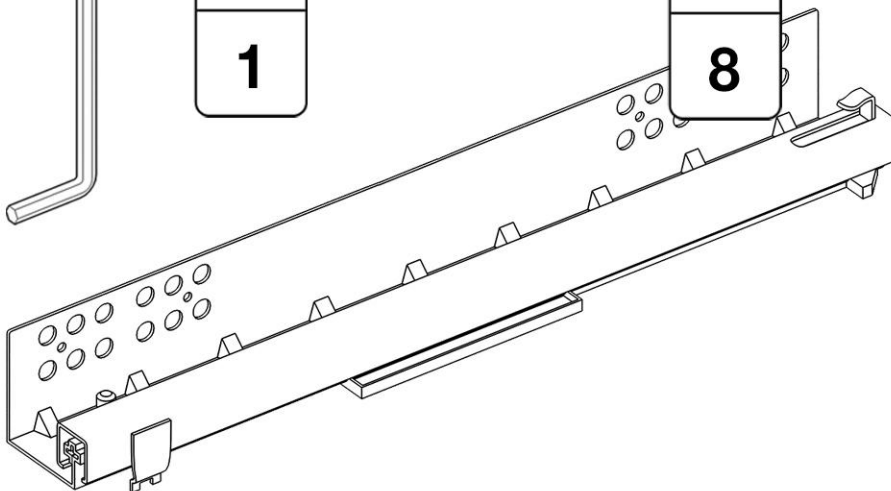

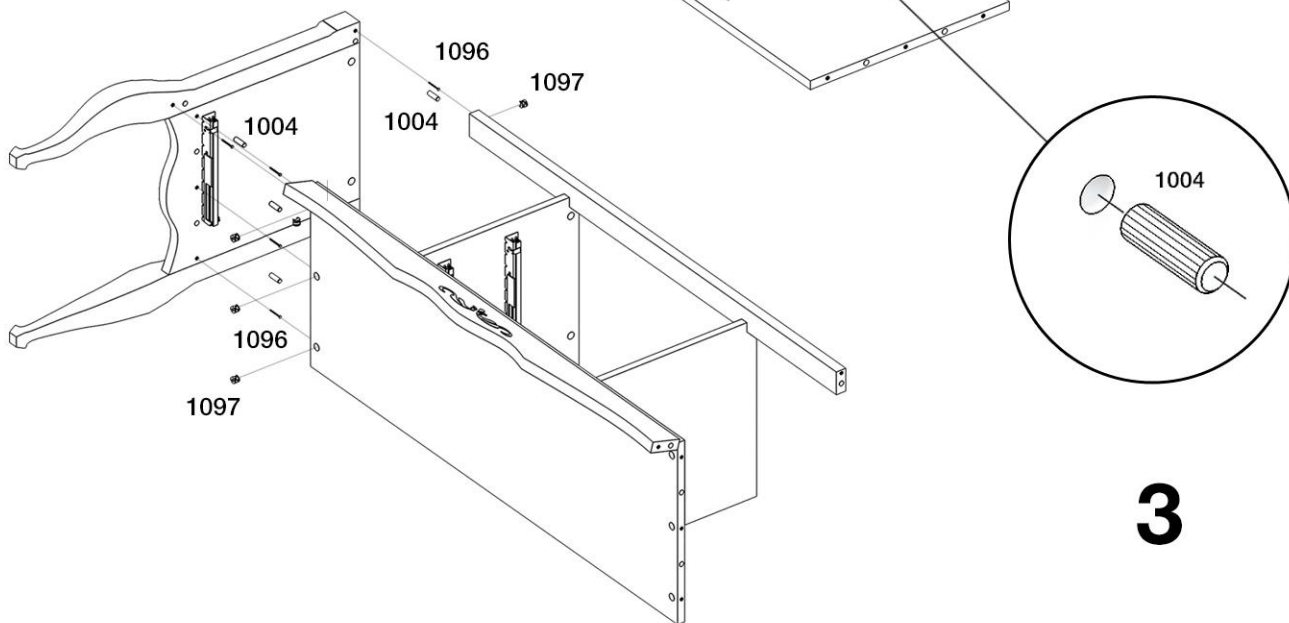
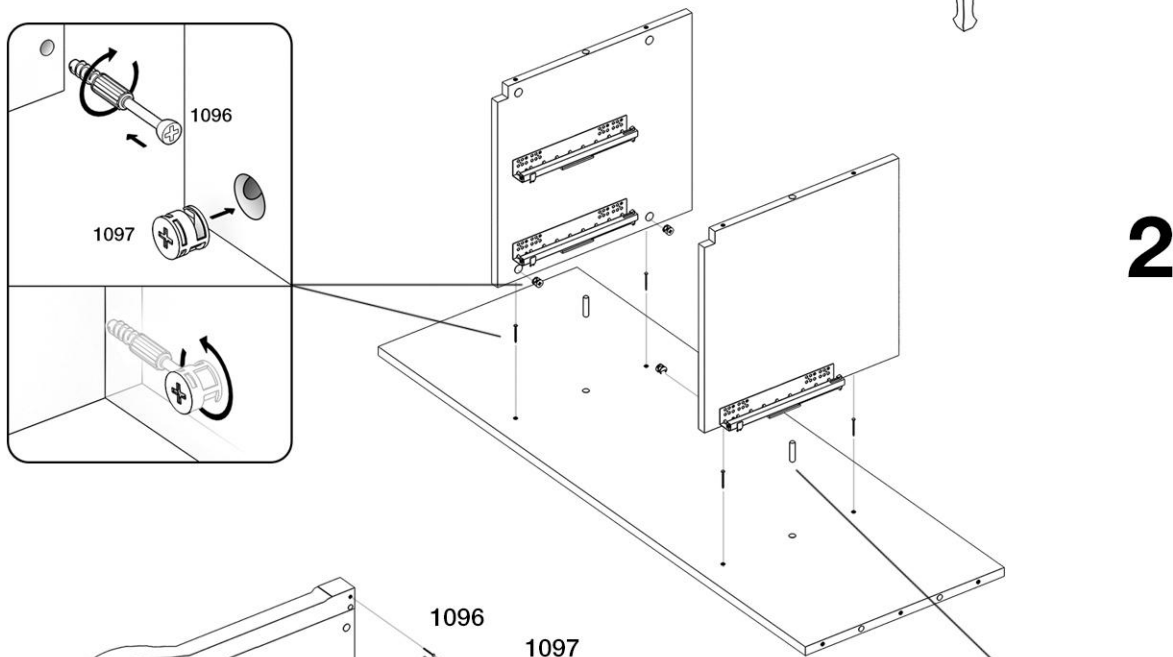
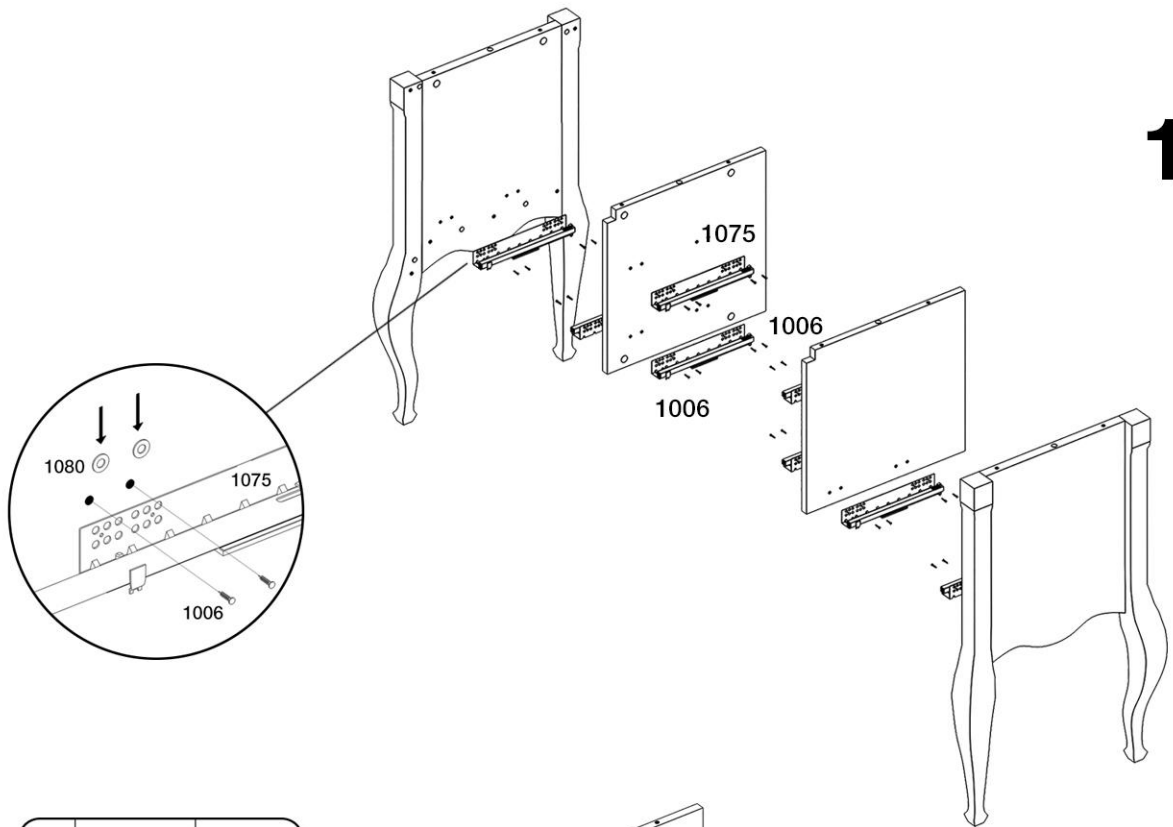

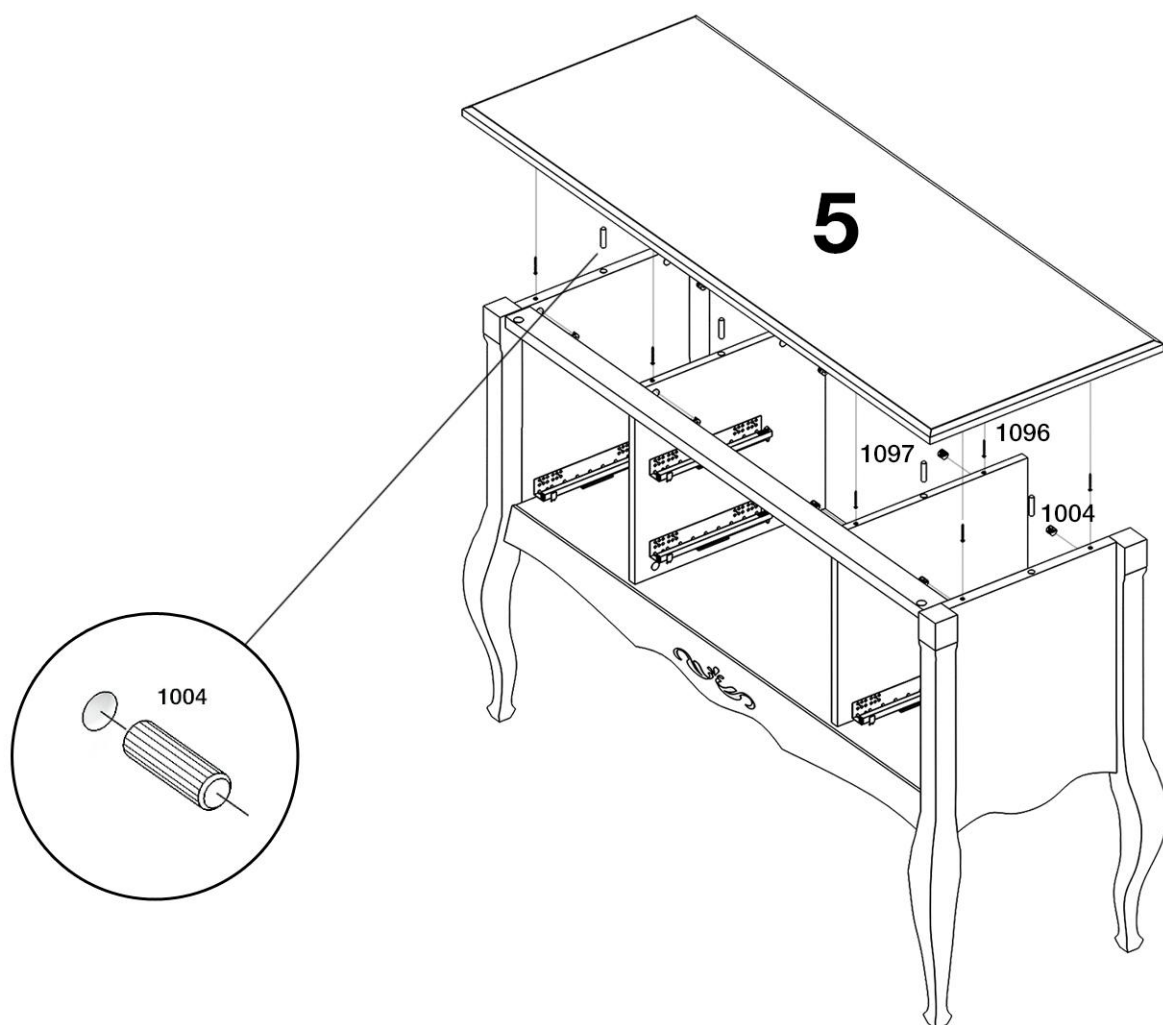
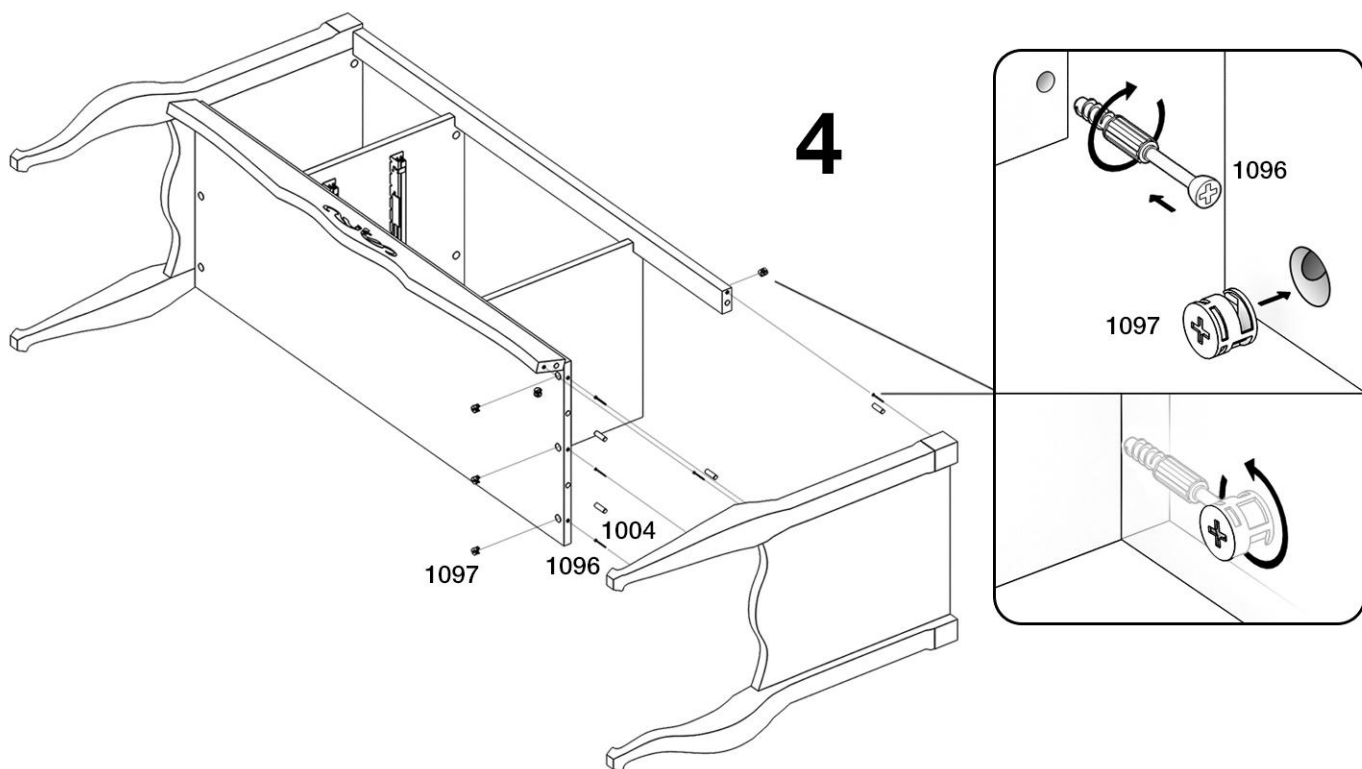

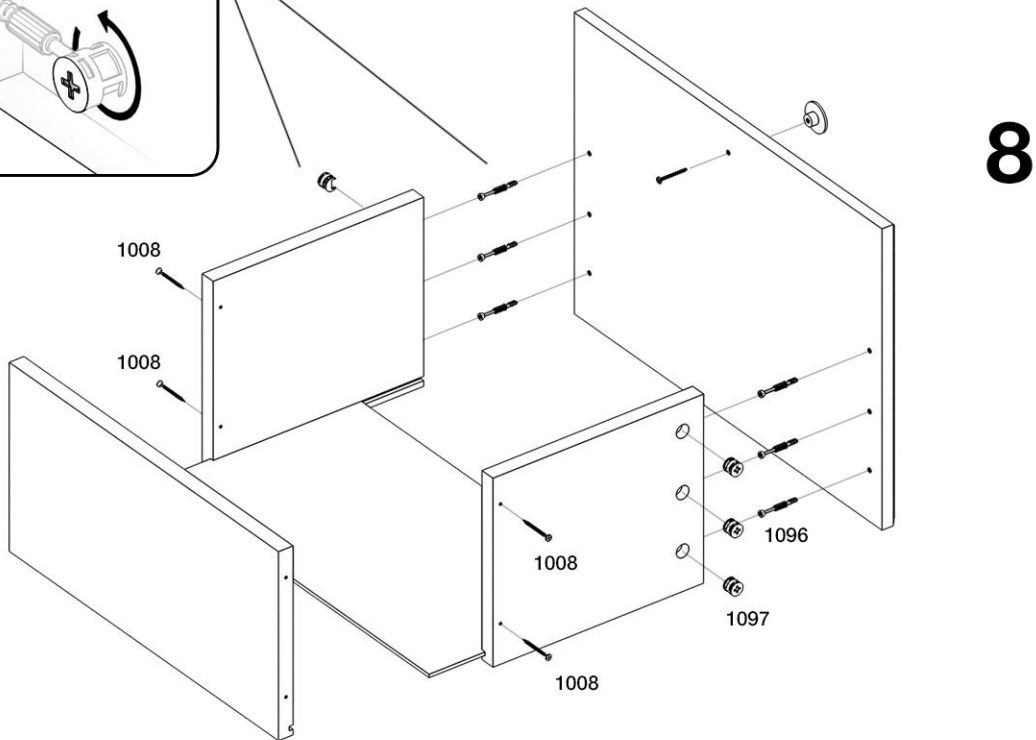
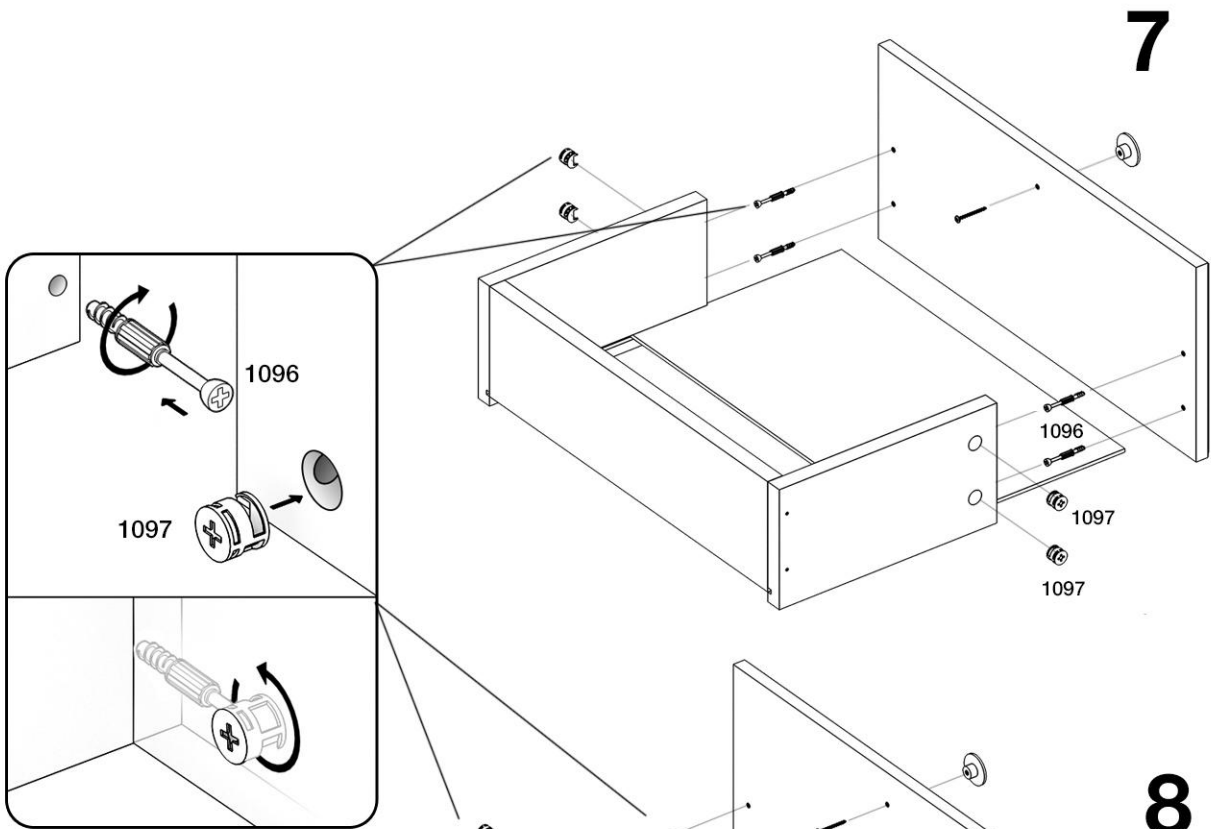
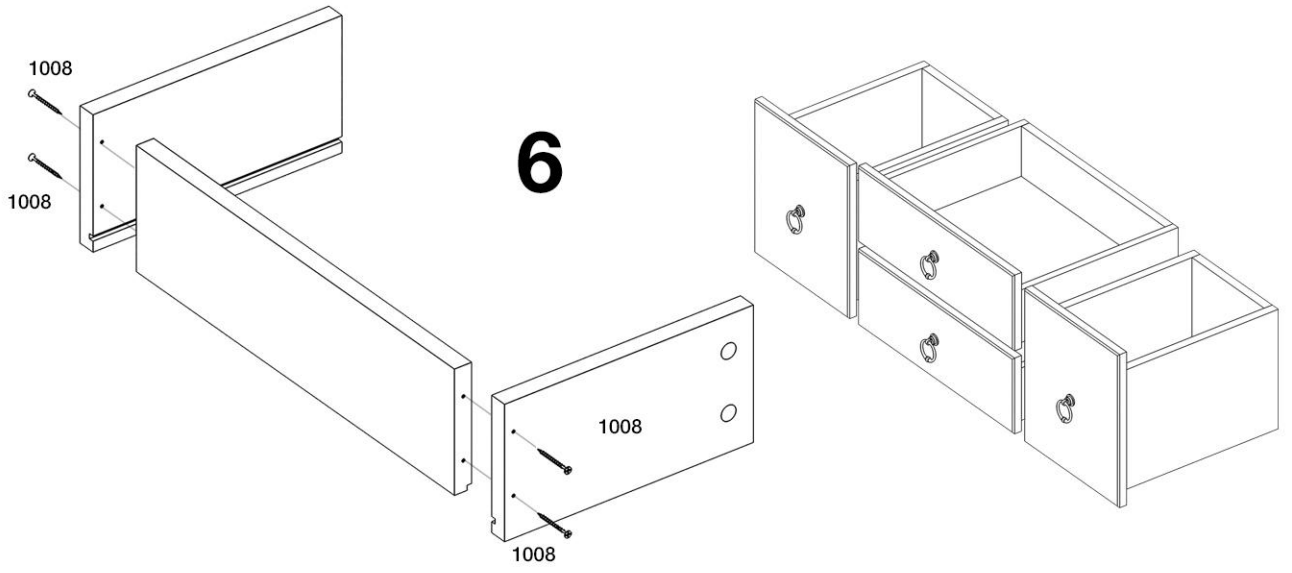

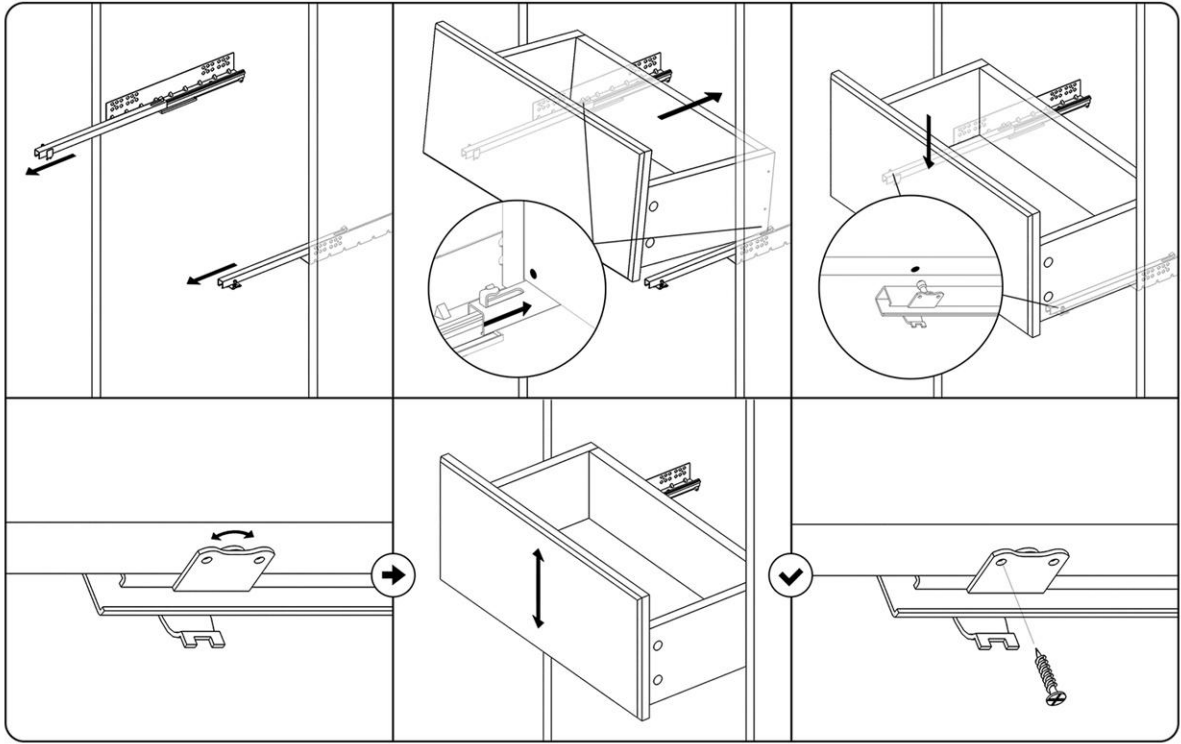

9

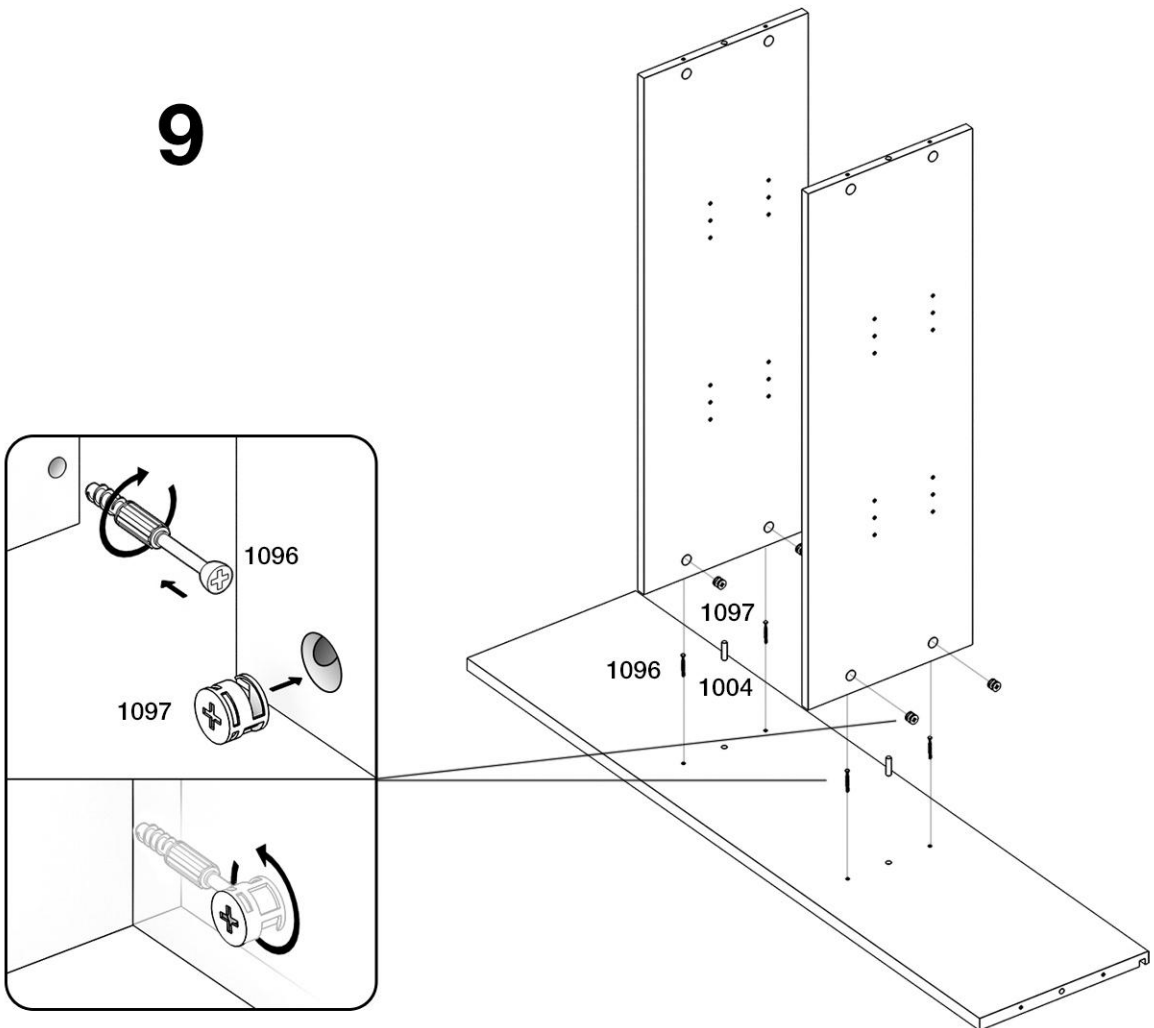

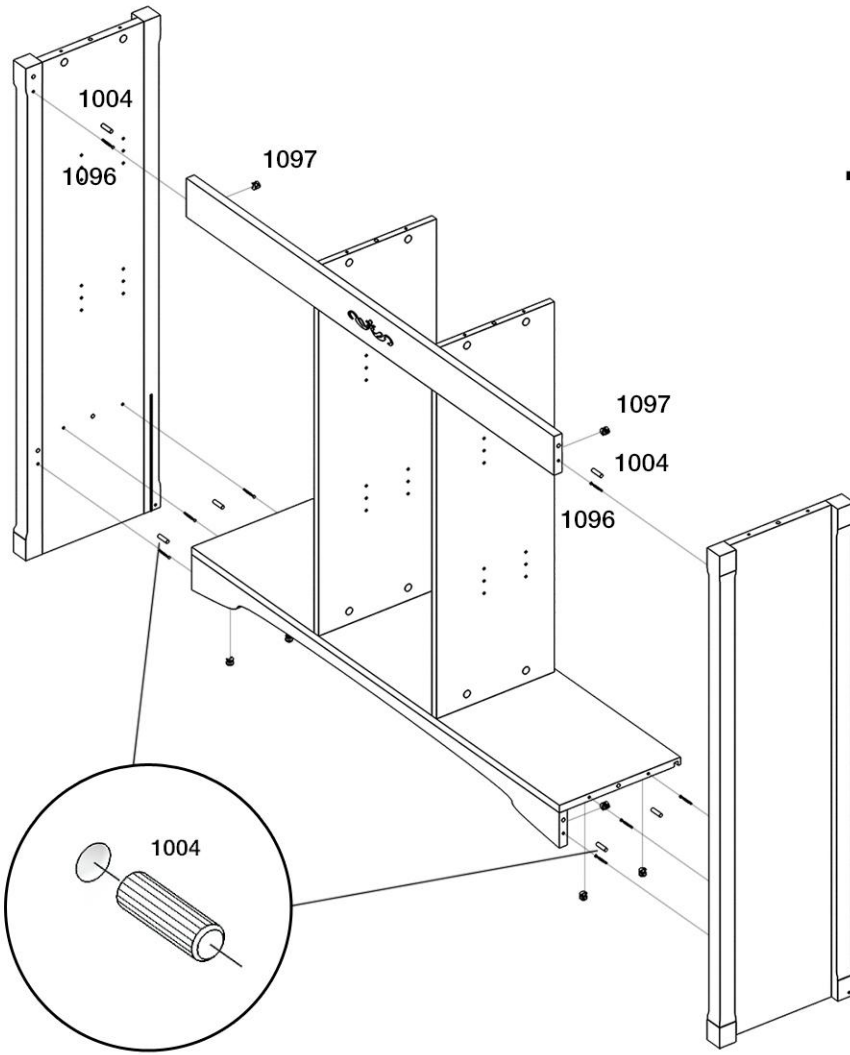

**10**

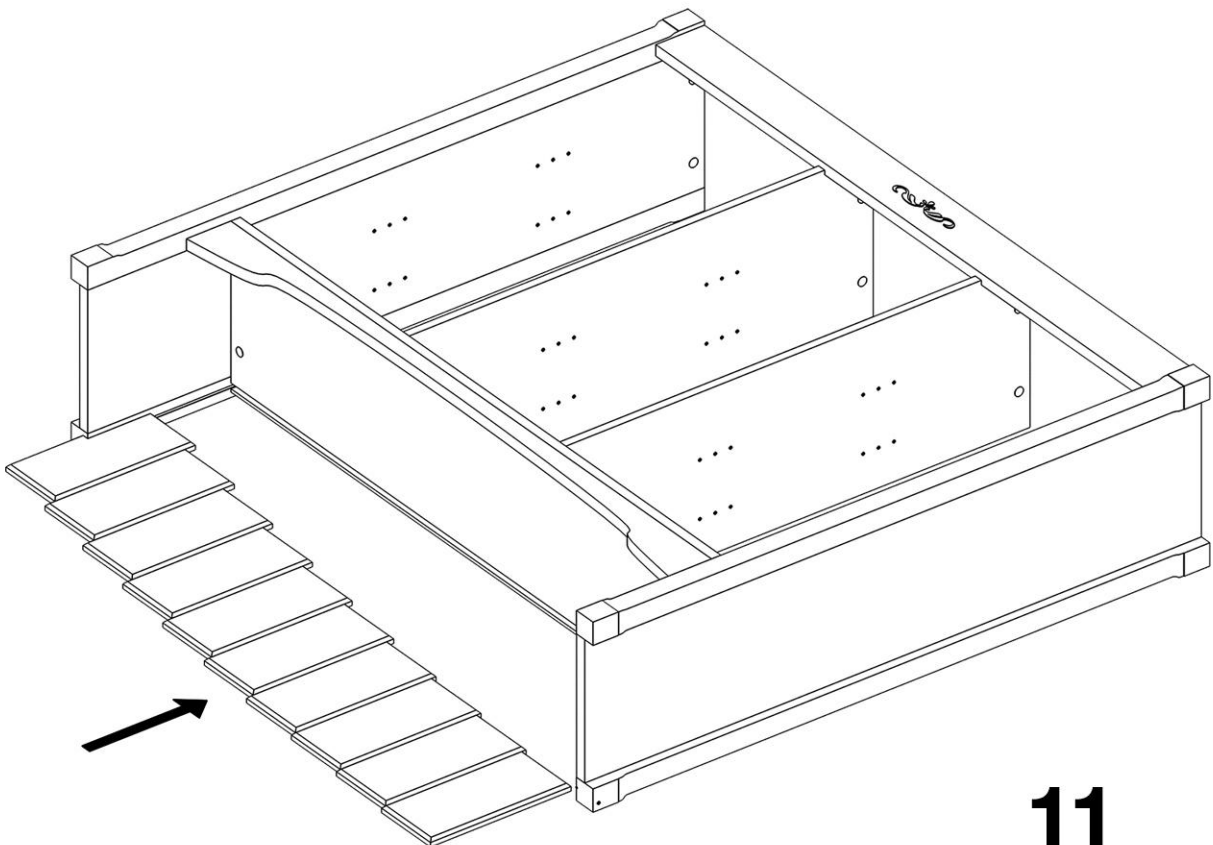

**11**

# 12

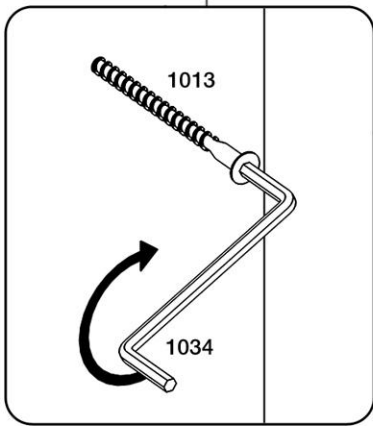
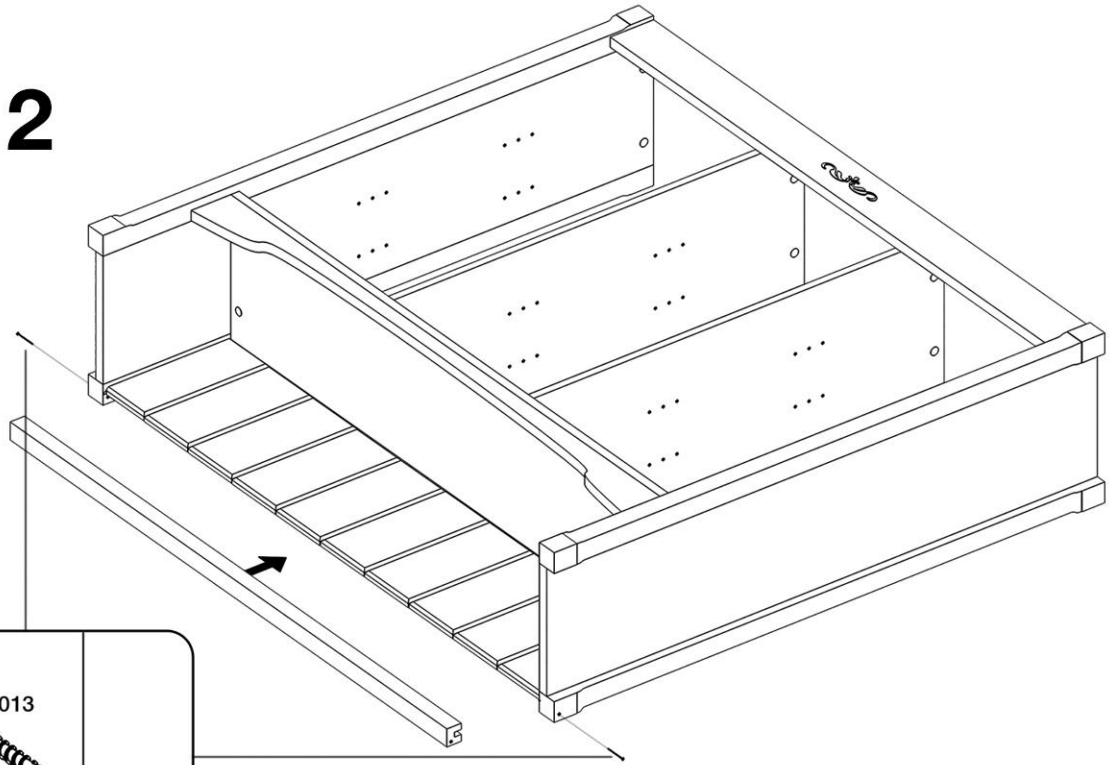

# 13

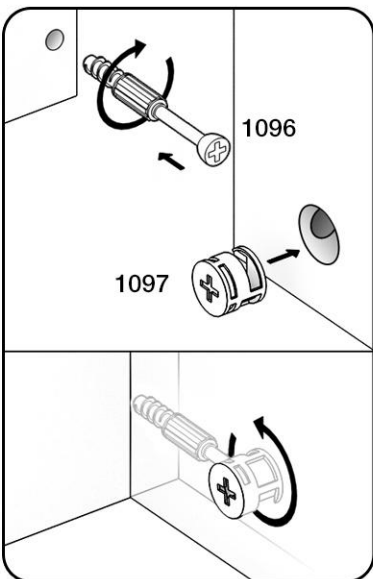
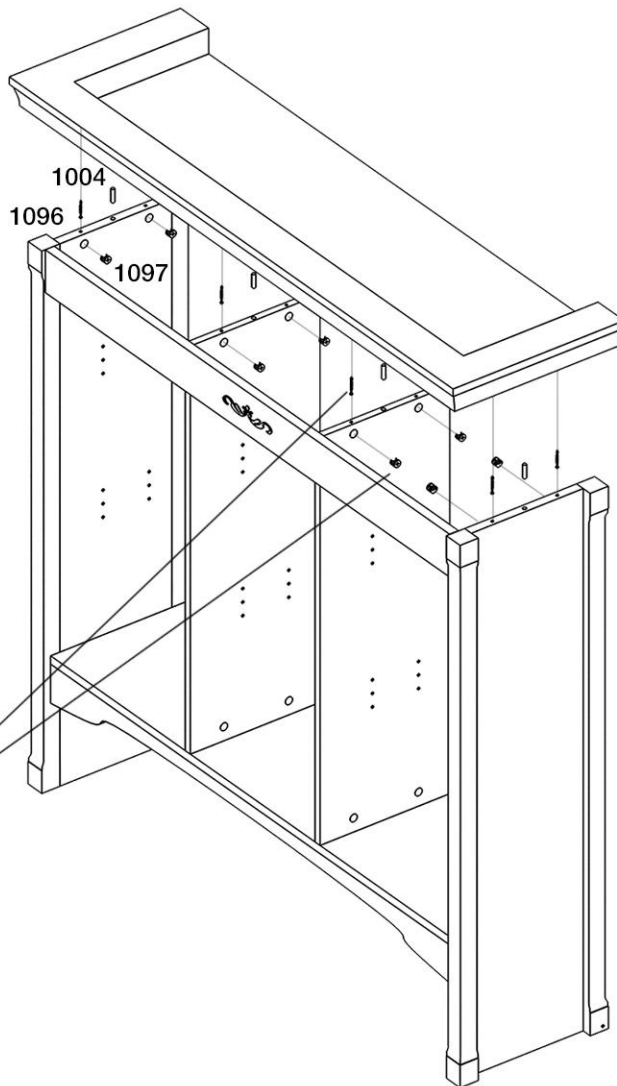



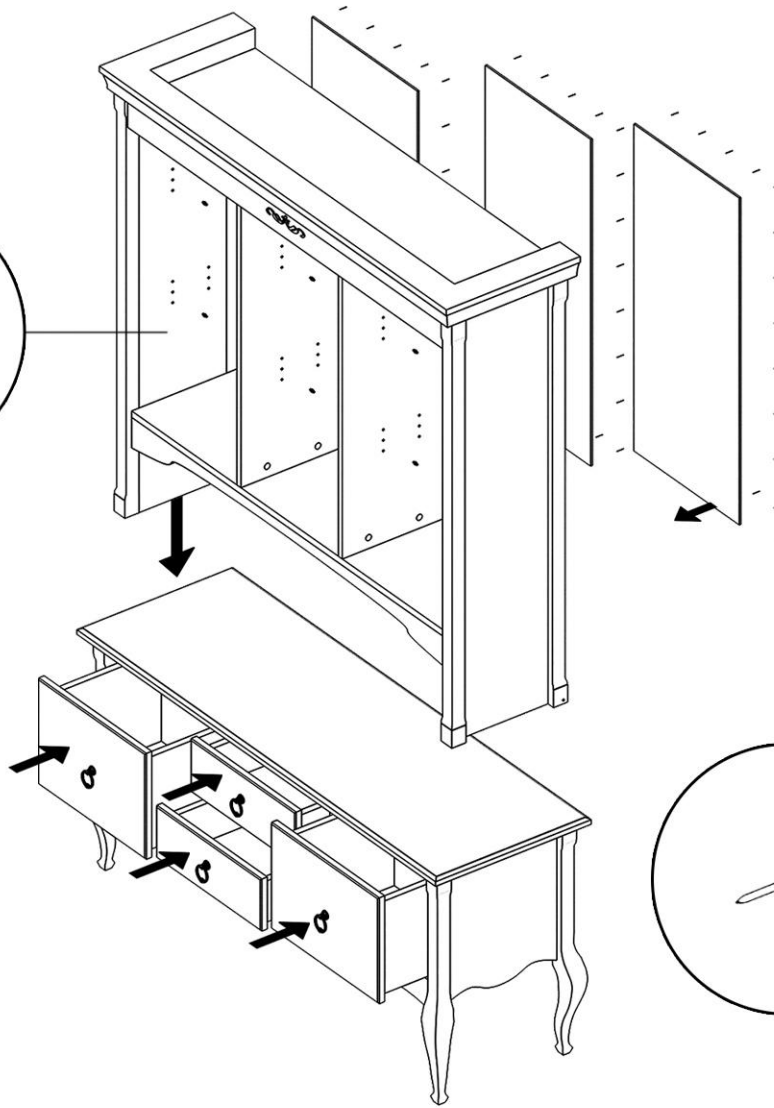
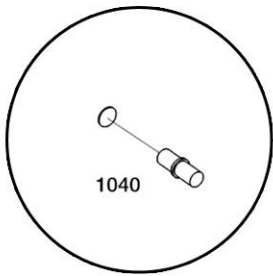

15

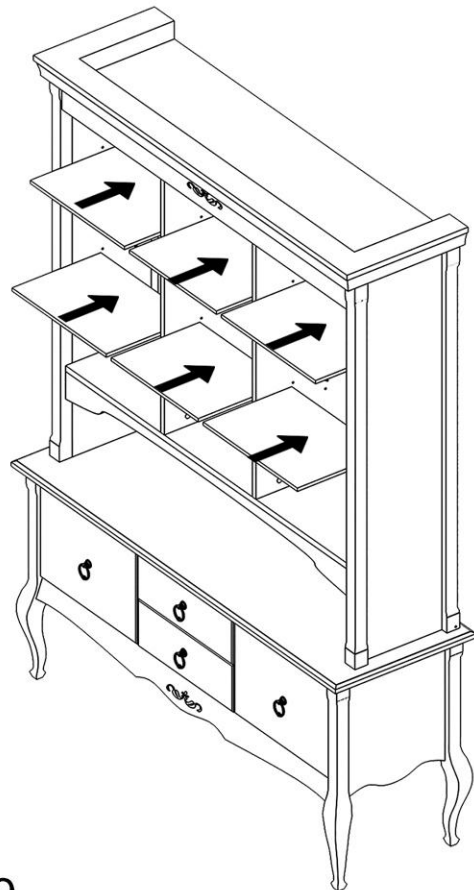

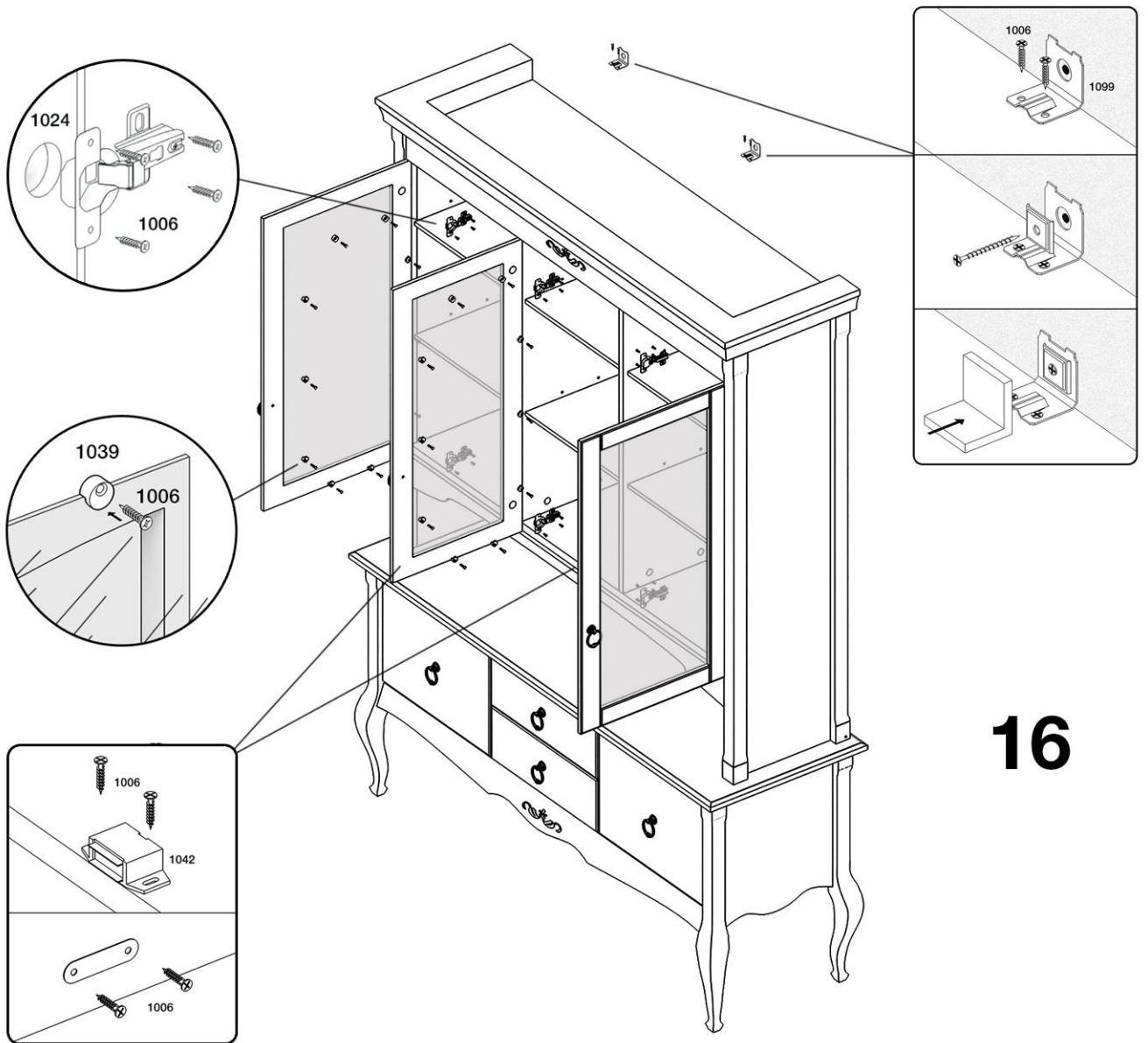

**16**

